

## Coperchio protettivo

Articolo 40787

- per spine, spine da parete e spine da pannello stagne all'acqua



## Specifiche tecniche

Corrente	63 A
Poli	5 p
Peso	107 g

## Disegni e dimensioni

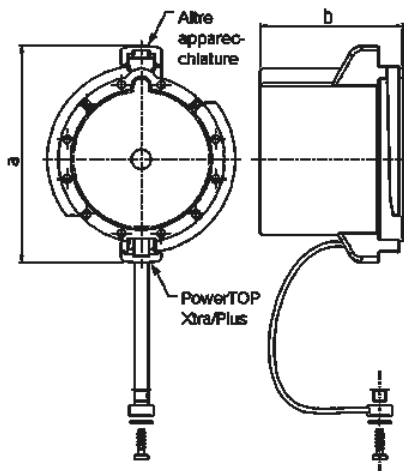

Disegno 2 MB 239	Amp. Poli	63			125		
		3	4	5	3	4	5
Dim. in mm	a	110			120		
	b	73			79		